

GEORGIAN CHAMPIONSHIP IN GR STYLE JUNIOR



UNITED WORLD
WRESTLING

TERJOLA (GEO)

2017-03-02 - 2017-03-04 2017

Résultats - Results

Lutte Greco-Romaine - Greco-Roman





Liste des Engagés par pays / Entry-List By Country

Georgian Championship in GR Style Junior

STYLE GR



GEORGIA (GEO)

Lutteur(s) / Wrestler(s) :

120 kg	CHKHAIDZE, Gia AJR DEVADZE, RAuli AJR ESADZE, Robinzoni OZRG KACHKACHISHVILI, Mamuka RST LOMIDZE, Nika KSHSR MAKARIDZE, Beqa TRJ SHPETISHVILI, Beqa GRDB SILAGADZE, Zaza TBL TSETSKHLADZE, Saba OZRG
50 kg	ABRAMASHVILI, Gurami GRDB ADIKASHVILI, Beqa GRDB FUTKARADZE, David AJR GHLONTI, Shota OZRG GHOGHOBERIDZE, Aleko AJR KHACHIDZE, Vasili BRJ OGANEZOVI, Zauri KSHSR SILAGAVA, Ramzi TBL ORC
55 kg	ABULADZE, Irakli AJR CHUBINIDZE, Tornike KTS DAVITADZE, Giorgi AJR DEKANADZE, Onise AJR DZIMISTARISHVILI, Irakli OZRG GOGIA, Temuri SNK IREMADZE, Nika OZRG JANELIDZE, Romani KTS KANDELAKI, Tornike GRDB MEGRELISHVILI, Nikoloz TBL NADARAIA, Dima MRTVL SEKHNIASHVILI, Daviti TBL SHAVADZE, Bachuki TBL TSURTSUMIA, Nugzari KHOBI
60 kg	ABULADZE, Leri KHULO BAKURIDZE, Daviti OZRG BERIDZE, Tornike AJR BREGVADZE, Giorgi RST CHELIDZE, Tornike AJR GUBELADZE, Lasha TSKLT GUJABIDZE, Giorgi OZRG GURULI, Mamuka RST IREMADZE, Gia AJR JANELIDZE, Tornike KTS JAVAKHADZE, Anzori OZRG KHETSURIANI, Joni KHOBI MCHEDLISHVILI, Daviti GRDB MEFISHVILI, Giorgi SNK
66 kg	ABULADZE, Otari AJR BABILODZE, Erekle OZR BABILUA, Saba SNK BUTSKHRIKIDZE, Giga TRJ CHOLADZE, Lasha KTS FTSQIALADZE, Lasha KSHSR GADILIA, Ramiko SNK GOGITIDZE, Elizbar TSLK GOGOCHURI, Torghva TBL KIRTAVA, Jiba SNK KORSHIA, Nika KHOBI



Liste des Engagés par pays / Entry-List By Country

Georgian Championship in GR Style Junior



STYLE GR

	KURTANIDZE, Giorgi GRDB
	LABADZE, Giorgi OZRG
	MACHALIKASHVILI, Qerim SGRJ
	MAMNIASHVILI, Otari GRDB
	MARKOIDZE, Davit AJR
	MELADZE, Tornike AJR
	METREVELI, Irakli TBL
	QAVTARADZE, Beqa TBL
	QINQLADZE, Tristani OZRG
	QUTATELADZE, Onise TSKLT
	RUSITASHVILI, Rostomi TBL
	SAMKHARAULI, Gizo GRDB
	SHAVADZE, Lado AJR
	SIMONIA, Zurabi SNK
	SOFROMADZE, Kote TRJ
	TAKASHVILI, Nika GRDB
	TSIKLAURI, Baqari OZRG
	TSKHADADZE, Saba KTS
	TSULUKIDZE, Giorgi AJR
74 kg	ALFAIDZE, Givi KTS
	ASANIDZE, Giorgi RST
	CHIKAIDZE, Nikoloz GRDB
	CHKHAIDZE, Rezo AJR
	CHUMBURIDZE, Omari TRJL
	ELIAVA, Gocha KTS
	GABUNIA, Giorgi KTS
	GAVASHELASHVILI, Shota TRJL
	GOGIDZE, Daviti KTS
	GOGOKHIA, Temuri KHOBI
	GOTUA, Vazha OZRG
	GURULI, Beqa RST
	IOSAVA, Shota KHOBI
	IREMADZE, Daviti AJR
	JANELIDZE, Badri KTS
	JINCHARADZE, Nikoloz TBL
	KUPRASHVILI, Guja KTS
	MAMUKASHVILI, Beqa GRDB
	POGHOSIANI, Sergo TBL
	QAJAIA, Paliko KHOBI
	QAVTARADZE, Demuri GRDB
	QUMELASHVILI, Jemali KTS
	RIKADZE, Aivengo GRDB
	SALUQVADZE, Mate OZRG
	SHAVADZE, Gela AJR
	SHPETISHVILI, Irodioni GRDB
	SHPETISHVILI, Zaqaria GRDB
	SHUBITIDZE, Tengizi GRDB
	SHVELIDZE, Evsem KHRGL
	TANGVERDIEVI, Nadir RST
	TSULAIA, Beqa KTS
	TURABELIDZE, Ucha KTS
	URUSHADZE, Giorgi OZRG
84 kg	AFTSIAURI, Valeriani AJR
	BOLGHASHVILI, Giorgi RST
	CHKHAIDZE, Elguja AJR
	CHKUASELIDZE, Temo BRJ
	GHARIBADZE, Koka TBL
	GIORGADZE, Valriane KTS
	GUMBERIDZE, Aleqsandre KTS
	KHETSURIANI, Gurami KTS
	KOGHOASHVILI, Giorgi KTS



Liste des Engagés par pays / Entry-List By Country

Georgian Championship in GR Style Junior



STYLE GR

96 kg

QARTVELISHVILI, Givi TBL
QATSANASHVILI, Giorgi GRDB
TATURASHVILI, Luka OZRG
TEVDORADZE, Givi KTS
ALBORISHVILI, Givi TSKLTB
BARBAQADZE, Giorgi GRDB
BUKHRIDZE, Saba TBL
FUTKARADZE, Zviadi AJR
GIORGOBIANI, Gurami TBL ORC
IREMADZE, Mamuka AJR
KALANDADZE, Kakha OZRG
KUSHTANASHVILI, Beslani AKHMT
MANCHKHASHVILI, Giorgi TBL
MARSHANIA, Giorgi TBL
ORBELADZE, Giorgi ZSTF
PATARAIA, Nikoloz TBL



Feuille de compétition / Competition Sheet

Georgian Championship in GR Style Junior



STYLE : GR 120 kg



Classement

Cl	Pays	Nom
1	GEO	MAKARIDZE Beqa TRJ
2	GEO	TSETSKHLADZE Saba OZRG
3	GEO	DEVADZE RAuli AJR
3	GEO	LOMIDZE Nika KHSR
5	GEO	SHPETISHVILI Beqa GRDB
5	GEO	ESADZE Robinzoni OZRG
7	GEO	SILAGADZE Zaza TBL
8	GEO	KACHKACHISHVILI Mamuka RST
9	GEO	CHKHAIDZE Gia AJR

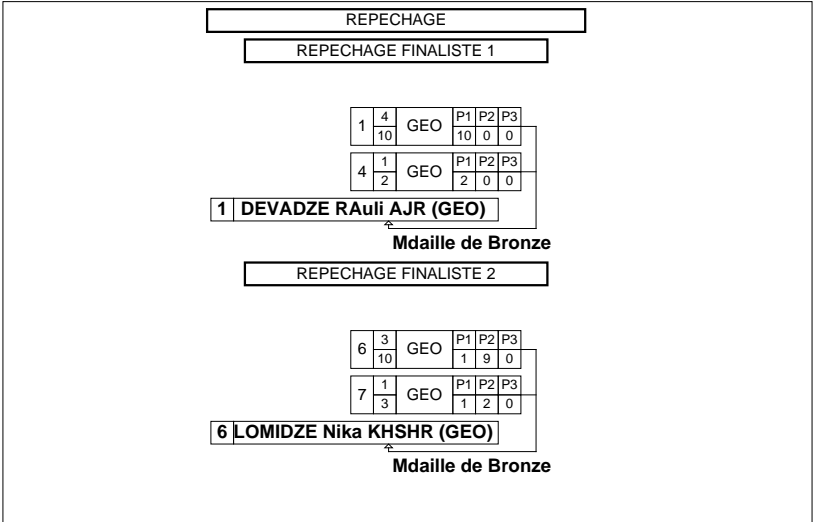

Classement**Georgian Championship in GR Style Junior**

STYLE : GR 120 kg

UNITED WORLD
WRESTLING**1 - Or / Gold**

MAKARIDZE Beqa TRJ

2 - Argent / Silver

TSETSKHLADZE Saba OZRG

3 - Bronze

DEVADZE RAuli AJR



LOMIDZE Nika KSHSR

Classement	Nom - Name	Pays - Country
1	MAKARIDZE Beqa TRJ	GEO
2	TSETSKHLADZE S.	GEO
3	DEVADZE RAuli AJR	GEO
3	LOMIDZE Nika KSHSR	GEO
5	SHPETISHVILI B.	GEO
5	ESADZE R.	GEO
7	SILAGADZE Zaza TBL	GEO
8	KACHKACHISHVILI M.	GEO
9	CHKHAIDZE Gia AJR	GEO



Feuille de compétition / Competition Sheet

Georgian Championship in GR Style Junior



STYLE : GR 50 kg



Classement

Cl	Pays	Nom
1	GEO	SILAGAVA Ramzi TBL ORC
2	GEO	GHLONTI Shota OZRG
3	GEO	ABRAMASHVILI Gurami GRDB
3	GEO	KHACHIDZE Vasili BRJ
5	GEO	FUTKARADZE David AJR
5	GEO	ADIKASHVILI Beqa GRDB
7	GEO	GHOGHOBERIDZE Aleko AJR
8	GEO	OGANEZOVI Zauri KHSHR

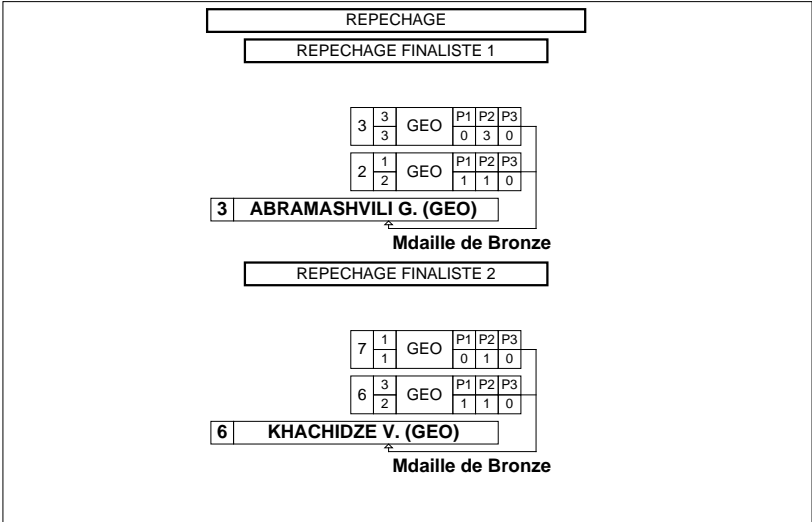

Classement**Georgian Championship in GR Style Junior**

STYLE : GR 50 kg

UNITED WORLD
WRESTLING**1 - Or / Gold**

SILAGAVA Ramzi TBL ORC

2 - Argent / Silver

GHLONTI Shota OZRG

3 - Bronze

ABRAMASHVILI Gurami GRDB KHACHIDZE Vasili BRJ

<i>Classement</i>	<i>Nom - Name</i>	<i>Pays - Country</i>
1	SILAGAVA R.	GEO
2	GHLONTI Shota OZRG	GEO
3	ABRAMASHVILI G.	GEO
3	KHACHIDZE V.	GEO
5	FUTKARADZE D.	GEO
5	ADIKASHVILI B.	GEO
7	GHOGHOBBERIDZE A.	GEO
8	OGANEZOVI Z.	GEO



Feuille de compétition / Competition Sheet

Georgian Championship in GR Style Junior



STYLE : GR 55 kg



14 TSURTSUMIA N. (GEO)

Classement

Cl	Pays	Nom
1	GEO	TSURTSUMIA Nugzari KHOBI
2	GEO	DZIMISTARISHVILI Irakli OZRG
3	GEO	GOGIA Temuri SNK
3	GEO	ABULADZE Irakli AJR
5	GEO	SHAVADZE Bachuki TBL
5	GEO	DEKANADZE Onise AJR
7	GEO	MEGRELISHVILI Nikoloz TBL
8	GEO	CHUBINIDZE Tornike KTS
9	GEO	KANDELAKI Tornike GRDB
10	GEO	DAVITADZE Giorgi AJR
11	GEO	JANELIDZE Romani KTS
12	GEO	SEKHNIASHVILI Daviti TBL
13	GEO	IREMADZE Nika OZRG
14	GEO	NADARAIA Dima MRTVL

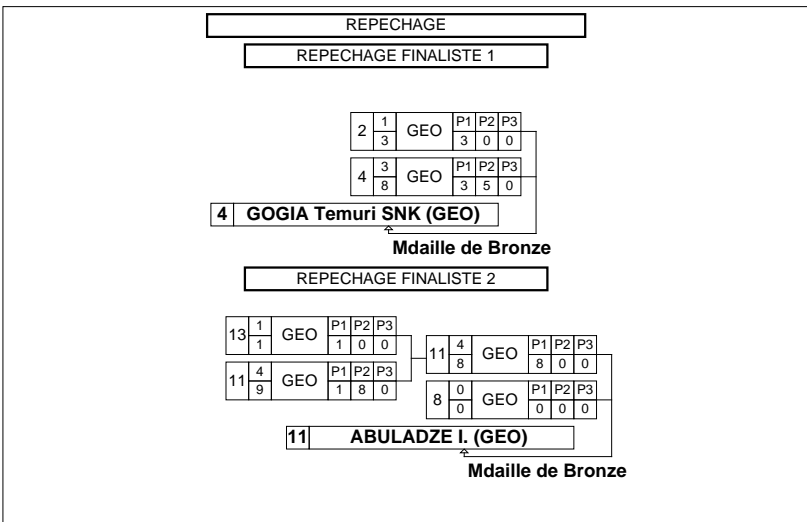

Classement**Georgian Championship in GR Style Junior**

STYLE : GR 55 kg

UNITED WORLD
WRESTLING**1 - Or / Gold**

TSURTSUMIA Nugzari KHOBI

2 - Argent / Silver

DZIMISTARISHVILI Irakli OZRG

3 - Bronze

GOGIA Temuri SNK



ABULADZE Irakli AJR

<i>Classement</i>	<i>Nom - Name</i>	<i>Pays - Country</i>
1	TSURTSUMIA N.	GEO
2	DZIMISTARISHVILI I.	GEO
3	GOGIA Temuri SNK	GEO
3	ABULADZE Irakli AJR	GEO
5	SHAVADZE B.	GEO
5	DEKANADZE Onise AJR	GEO
7	MEGRELISHVILI N.	GEO
8	CHUBINIDZE T.	GEO
9	KANDELAKI T.	GEO
10	DAVITADZE G.	GEO
11	JANELIDZE R.	GEO
12	SEKHNIASHVILI D.	GEO
13	IREMADZE Nika OZRG	GEO
14	NADARAIA Dima MRTVL	GEO



Feuille de compétition / Competition Sheet

Georgian Championship in GR Style Junior



STYLE : GR 60 kg



14 ABULADZE L. (GEO)

Classement

Cl	Pays	Nom
1	GEO	ABULADZE Leri KHULO
2	GEO	BAKURIDZE Daviti OZRG
3	GEO	KHETSURIANI Joni KHOBI
3	GEO	GUJABIDZE Giorgi OZRG
5	GEO	IREMADZE Gia AJR
5	GEO	MEFISHVILI Giorgi SNK
7	GEO	CHELIDZE Tornike AJR
8	GEO	GUBELADZE Lasha TSKLT
9	GEO	BERIDZE Tornike AJR
10	GEO	JAVAKHADZE Anzori OZRG
11	GEO	JANELIDZE Tornike KTS
12	GEO	BREGVADZE Giorgi RST
12	GEO	GURULI Mamuka RST
14	GEO	MCHEDLISHVILI Daviti GRDB

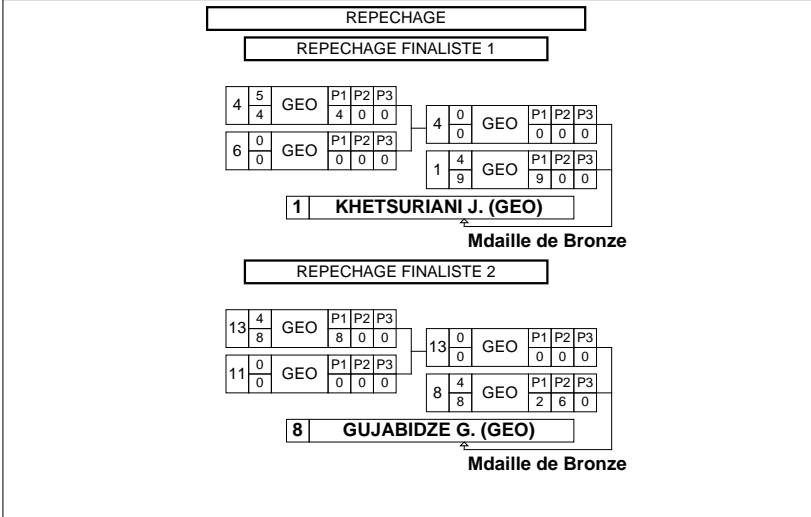

Classement**Georgian Championship in GR Style Junior**

STYLE : GR 60 kg

UNITED WORLD
WRESTLING**1 - Or / Gold**

ABULADZE Leri KHULO

2 - Argent / Silver

BAKURIDZE Daviti OZRG

3 - Bronze

KHETSURIANI Joni KHOBI GUJABIDZE Giorgi OZRG

<i>Classement</i>	<i>Nom - Name</i>	<i>Pays - Country</i>
1	ABULADZE Leri KHULO	GEO
2	BAKURIDZE D.	GEO
3	KHETSURIANI J.	GEO
3	GUJABIDZE G.	GEO
5	IREMADZE Gia AJR	GEO
5	MEFISHVILI G.	GEO
7	CHELIDZE T.	GEO
8	GUBELADZE L.	GEO
9	BERIDZE Tornike AJR	GEO
10	JAVAKHADZE A.	GEO
11	JANELIDZE T.	GEO
12	BREGVADZE G.	GEO
12	GURULI Mamuka RST	GEO
14	MCHEDLISHVILI D.	GEO



UNITED WORLD
WRESTLING

Feuille de compétition / Competition Sheet

Georgian Championship in GR Style Junior



STYLE : GR 66 kg

QUALIFICATION			1/8 FINALE			1/4 FINALE			1/2 FINALE			FINALE		
1		TSULUKIDZE G. (GEO)				1	1	GEO	P1	P2	P3			
							2		2	0	0			
2		ABULADZE Otari AJR (GEO)				2	3	GEO	P1	P2	P3			
							4		3	1	0			
3	3	CHOLADZE Lasha KTS (GEO)	P1	P2	P3	3	0	GEO	P1	P2	P3			
	6		3	3	0		0		0	0	0			
4	1	BABILODZE E. (GEO)	P1	P2	P3	5	0	GEO	P1	P2	P3			
	3		0	3	0		8		3	5	0			
5	4	MARKOIDZE D. (GEO)	P1	P2	P3	5	4	GEO	P1	P2	P3			
	12		12	0	0		10		4	6	0			
6	1	TSIKLAURI B. (GEO)	P1	P2	P3	7	0	GEO	P1	P2	P3			
	1		1	0	0		0		0	0	0			
7	4	GADILIA Ramiko SNK (GEO)	P1	P2	P3	9	4	GEO	P1	P2	P3			
	9		9	0	0		8		8	0	0			
8	0	SOFROMADZE K. (GEO)	P1	P2	P3	9	4	GEO	P1	P2	P3			
	0		0	0	0		9		9	0	0			
9	4	BUTSKHRIKIDZE G. (GEO)	P1	P2	P3	10	0	GEO	P1	P2	P3			
	8		4	4	0		0		0	0	0			
10	0	GOGOCHURI T. (GEO)	P1	P2	P3	12	3	GEO	P1	P2	P3			
	0		0	0	0		9		1	8	0			
11	0	METREVELI I. (GEO)	P1	P2	P3	12	0	GEO	P1	P2	P3			
	0		0	0	0		0		0	0	0			
12	5	MELADZE T. (GEO)	P1	P2	P3	14	1	GEO	P1	P2	P3			
	11		11	0	0		2		0	2	0			
13	0	QAVTARADZE B. (GEO)	P1	P2	P3	16	3	GEO	P1	P2	P3			
	0		0	0	0		4		1	3	0			
14	4	KORSHIA Nika KHOBI (GEO)	P1	P2	P3	16	3	GEO	P1	P2	P3			
	9		9	0	0		4		0	4	0			
15	0	TAKASHVILI N. (GEO)	P1	P2	P3	17	0	GEO	P1	P2	P3			
	0		0	0	0		0		0	0	0			
16	4	SHAVADZE Lado AJR (GEO)	P1	P2	P3	19	4	GEO	P1	P2	P3			
	8		3	5	0		9		9	0	0			
17	4	KIRTAVA Jiba SNK (GEO)	P1	P2	P3	19	1	GEO	P1	P2	P3			
	9		5	4	0		1		1	0	0			
18	0	TSKHADADZE S. (GEO)	P1	P2	P3	21	0	GEO	P1	P2	P3			
	0		0	0	0		0		0	0	0			
19	3	SAMKHARALI G. (GEO)	P1	P2	P3	21	0	GEO	P1	P2	P3			
	5		2	3	0		0		0	0	0			
20	0	RUSITASHVILI R. (GEO)	P1	P2	P3	23	3	GEO	P1	P2	P3			
	0		0	0	0		4		0	4	0			
21	4	QINQLADZE T. (GEO)	P1	P2	P3	23	1	GEO	P1	P2	P3			
	22		10	12	0		2		2	0	0			
22	1	GOGITIDZE E. (GEO)	P1	P2	P3	25	1	GEO	P1	P2	P3			
	11		6	5	0		2		2	0	0			
23	4	MACHALIKASHVILI Q. (GEO)	P1	P2	P3	28	0	GEO	P1	P2	P3			
	11		10	1	0		0		0	0	0			
24	1	LABADZE G. (GEO)	P1	P2	P3	28	4	GEO	P1	P2	P3			
	3		3	0	0		11		7	4	0			
25	4	MAMNIASHVILI O. (GEO)	P1	P2	P3	29	4	GEO	P1	P2	P3			
	9		7	2	0		8		8	0	0			
26	0	QUTATELADZE O. (GEO)	P1	P2	P3	29	8	GEO	P1	P2	P3			
	0		0	0	0		0		0	0	0			
27	0	BABILUA Saba SNK (GEO)	P1	P2	P3									
	0		0	0	0									
28	5	SIMONIA Zurabi SNK (GEO)	P1	P2	P3									
	0		0	0	0									
29	4	KURTANIDZE G. (GEO)	P1	P2	P3									
	9		9	0	0									
30	0	FTSQIALADZE L. (GEO)	P1	P2	P3									
	0		0	0	0									

29 KURTANIDZE G. (GEO)

Classement

Cl	Pays	Nom
1	GEO	KURTANIDZE Giorgi GRDB
2	GEO	ABULADZE Otari AJR
3	GEO	BUTSKHRIKIDZE Giga TRJ
3	GEO	MACHALIKASHVILI Qerim SGRJ
5	GEO	MARKOIDZE Davit AJR
5	GEO	SHAVADZE Lado AJR
7	GEO	SIMONIA Zurabi SNK
8	GEO	MELADZE Tornike AJR
9	GEO	SAMKHARALI Gizo GRDB
10	GEO	MAMNIASHVILI Otari GRDB
11	GEO	KORSHIA Nika KHOBI
12	GEO	QINQLADZE Tristani OZRG
13	GEO	GADILIA Ramiko SNK
14	GEO	KIRTAVA Jiba SNK
15	GEO	CHOLADZE Lasha KTS
16	GEO	TSULUKIDZE Giorgi AJR
17	GEO	GOGITIDZE Elizbar TSLK
18	GEO	BABILODZE Erekle OZR
19	GEO	LABADZE Giorgi OZRG
20	GEO	TSIKLAURI Baqari OZRG
21	GEO	BABILUA Saba SNK
22	GEO	RUSITASHVILI Rostomi TBL
23	GEO	TAKASHVILI Nika GRDB
23	GEO	GOGOCHURI Torghva TBL
25	GEO	QUTATELADZE Onise TSKLT
25	GEO	SOFROMADZE Kote TRJ
25	GEO	QAVTARADZE Beqa TBL
29	GEO	METREVELI Irakli TBL
30	GEO	FTSQIALADZE Lasha KHSR

REPECHAGE

REPECHAGE FINALISTE 1

1	1	GEO	P1	P2	P3	5	1	GEO	P1	P2	P3
	5		4	1	0		3		0	3	0
5	3	GEO	P1	P2	P3	9	3	GEO	P1	P2	P3
	8		1	7	0		4		2	2	0

9 BUTSKHRIKIDZE G. (GEO)

Mdaille de Bronze

REPECHAGE FINALISTE 2

30	0	GEO	P1	P2	P3	28	0	GEO	P1	P2	P3	23	3	GEO	P1	P2	P3
	0		0	0	0		0		0	0	0		5		0	5	0
28	5	GEO	P1	P2	P3	23	4	GEO	P1	P2	P3	16	1	GEO	P1	P2	P3
	3		3	0	0		8		1	7	0		4		1	3	0

23 MACHALIKASHVILI Q. (GEO)

Mdaille de Bronze

Classement**Georgian Championship in GR Style Junior**

STYLE : GR 66 kg

**1 - Or / Gold**

KURTANIDZE Giorgi GRDB

2 - Argent / Silver

ABULADZE Otari AJR

3 - Bronze

BUTSKHRIKIDZE Giga TR MACHALIKASHVILI Qerim SGRJ

Classement	Nom - Name	Pays - Country
1	KURTANIDZE G.	GEO
2	ABULADZE Otari AJR	GEO
3	BUTSKHRIKIDZE G.	GEO
3	MACHALIKASHVILI Q.	GEO
5	MARKOIDZE Davit AJR	GEO
5	SHAVADZE Lado AJR	GEO
7	SIMONIA Zurabi SNK	GEO
8	MELADZE Tornike AJR	GEO
9	SAMKHARAUJI G.	GEO
10	MAMNIASHVILI O.	GEO
11	KORSHIA Nika KHOB	GEO
12	QINQLADZE T.	GEO
13	GADILIA Ramiko SNK	GEO
14	KIRTAVA Jiba SNK	GEO
15	CHOLADZE Lasha KTS	GEO
16	TSULUKIDZE G.	GEO
17	GOGITIDZE E.	GEO
18	BABILODZE E.	GEO
19	LABADZE Giorgi OZRG	GEO
20	TSIKLAURI B.	GEO
21	BABILUA Saba SNK	GEO
22	RUSITASHVILI R.	GEO
23	TAKASHVILI N.	GEO
23	GOGOCHURI T.	GEO
25	TSKHADADZE Saba KTS	GEO
25	QUTATELADZE O.	GEO
25	SOFROMADZE Kote TRJ	GEO
25	QAVTARADZE Beqa TBL	GEO
29	METREVELI I.	GEO
30	FTSQIALADZE L.	GEO



Feuille de compétition / Competition Sheet

Georgian Championship in GR Style Junior

STYLE : GR 74 kg



Classement

Cl	Pays	Nom
1	GEO	MAMUKASHVILI Beqa GRDB
2	GEO	SHUBITIDZE Tengizi GRDB
3	GEO	RIKADZE Aivengo GRDB
3	GEO	GOGIDZE Daviti KTS
5	GEO	GURULI Beqa RST
5	GEO	GOTUA Vazha OZRG
7	GEO	URUSHADZE Giorgi OZRG
8	GEO	SHAVADZE Gela AJR
9	GEO	JANELIDZE Badri KTS
10	GEO	POGHOSIANI Sergio TBL
11	GEO	KUPRASHVILI Guja KTS
12	GEO	TURABELIDZE Ucha KTS
13	GEO	CHIKAIDZE Nikoloz GRDB
14	GEO	GOGOKHIA Temuri KHOB
15	GEO	CHKHAIDZE Rezo AJR
16	GEO	SHPETISHVILI Irodioni GRDB
17	GEO	IREMADZE Daviti AJR
18	GEO	SALUQVADZE Mate OZRG
19	GEO	QAJAIA Paliko KHOB
20	GEO	QAVTARADZE Demuri GRDB

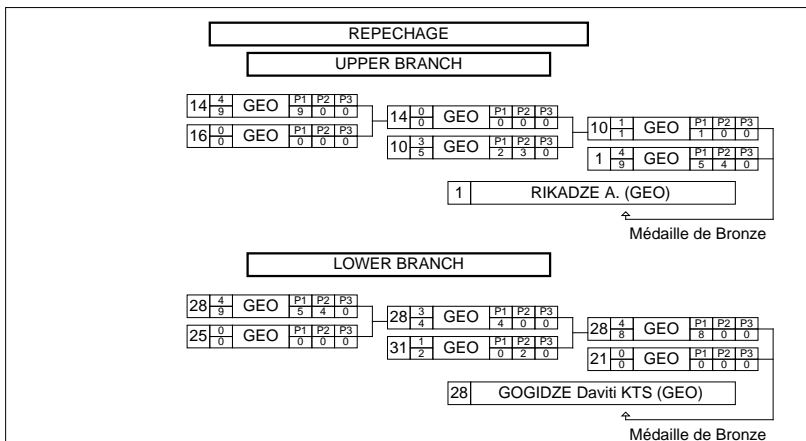

Classement**Georgian Championship in GR Style Junior**

STYLE : GR 74 kg

**1 - Or / Gold**

MAMUKASHVILI Beqa GRDB

2 - Argent / Silver

SHUBITIDZE Tengizi GRDB

3 - Bronze

RIKADZE Aivengo GRDB



GOGIDZE Daviti KTS

<i>Classement</i>	<i>Nom - Name</i>	<i>Pays - Country</i>
1	MAMUKASHVILI B.	GEO
2	SHUBITIDZE T.	GEO
3	RIKADZE A.	GEO
3	GOGIDZE Daviti KTS	GEO
5	GURULI Beqa RST	GEO
5	GOTUA Vazha OZRG	GEO
7	URUSHADZE G.	GEO
8	SHAVADZE Gela AJR	GEO
9	JANELIDZE Badri KTS	GEO
10	POGHOSIANI S.	GEO
11	KUPRASHVILI G.	GEO
12	TURABELIDZE U.	GEO
13	CHIKAIDZE N.	GEO
14	GOGOKHIA T.	GEO
15	CHKHAIDZE Rezo AJR	GEO
16	SHPETISHVILI I.	GEO
17	IREMADZE Daviti AJR	GEO
18	SALUQVADZE M.	GEO
19	QAJAIA Paliko KHOBI	GEO
20	QAVTARADZE D.	GEO
21	IOSAVA Shota KHOBI	GEO
22	SHPETISHVILI Z.	GEO
23	TSULAIA Beqa KTS	GEO
24	QUMELASHVILI J.	GEO
25	GAVASHELASHVILI S.	GEO
26	ASANIDZE Giorgi RST	GEO
26	JINCHARADZE N.	GEO
28	ELIAVA Gocha KTS	GEO
29	TANGVERDIEVI N.	GEO
29	ALFAIDZE Givi KTS	GEO



Classement

Georgian Championship in GR Style Junior

STYLE : GR 74 kg

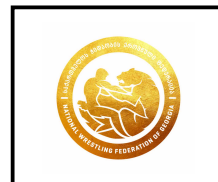

<i>Classement</i>	<i>Nom - Name</i>	<i>Pays - Country</i>
31	GABUNIA Giorgi KTS	GEO
31	CHUMBURIDZE O.	GEO
33	SHVELIDZE E.	GEO



Feuille de compétition / Competition Sheet

Georgian Championship in GR Style Junior



STYLE : GR 84 kg

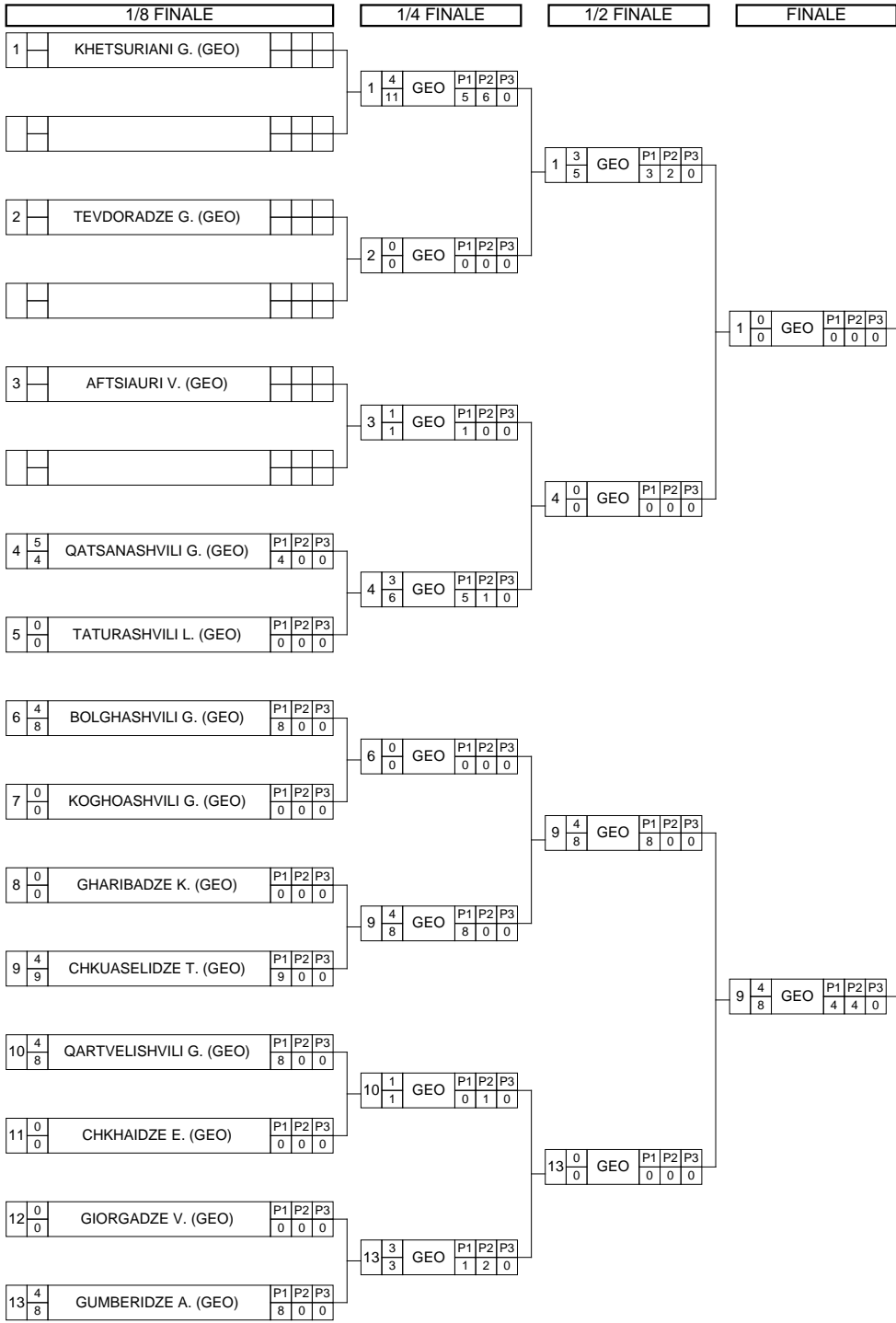

9 CHKUASELIDZE T. (GEO)

Classement

Cl	Pays	Nom
1	GEO	CHKUASELIDZE Temo BRJ
2	GEO	KHETSURIANI Gurami KTS
3	GEO	QATSANASHVILI Giorgi GRDB
3	GEO	GUMBERIDZE Aleksandre KTS
5	GEO	TEVDORADZE Givi KTS
5	GEO	BOLGHASHVILI Giorgi RST
7	GEO	QARTVELISHVILI Givi TBL
8	GEO	AFTSIAURI Valeriani AJR
9	GEO	TATURASHVILI Luka OZRG
10	GEO	CHKHAIDZE Elguja AJR
10	GEO	GIORGADZE Valriane KTS
10	GEO	KOGHOASHVILI Giorgi KTS
13	GEO	GHARIBADZE Koka TBL

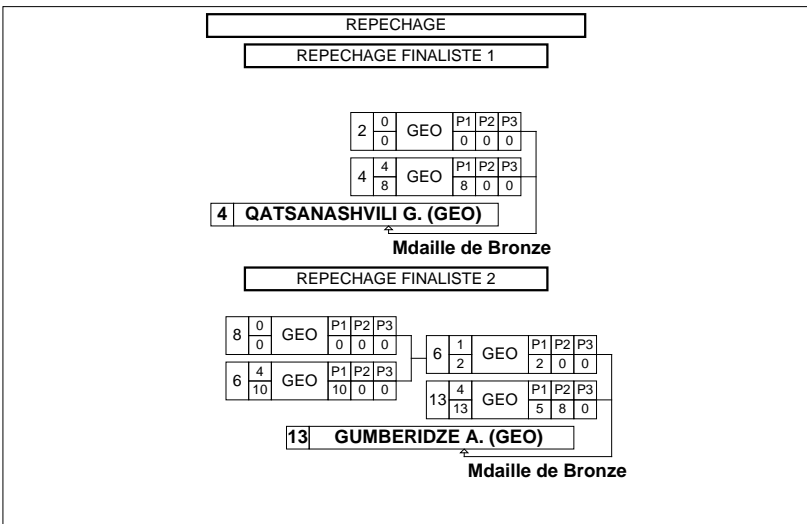

Classement**Georgian Championship in GR Style Junior**

STYLE : GR 84 kg

UNITED WORLD
WRESTLING

1 - Or / Gold



CHKUASELIDZE Temo BRJ

2 - Argent / Silver



KHETSURIANI Gurami KTS

3 - Bronze

QATSANASHVILI Giorgi GRJ
GUMBERIDZE Aleksandre KTS

Classement	Nom - Name	Pays - Country
1	CHKUASELIDZE T.	GEO
2	KHETSURIANI G.	GEO
3	QATSANASHVILI G.	GEO
3	GUMBERIDZE A.	GEO
5	TEVDORADZE Givi KTS	GEO
5	BOLGHASHVILI G.	GEO
7	QARTVELISHVILI G.	GEO
8	AFTSIAURI V.	GEO
9	TATURASHVILI L.	GEO
10	CHKHAIDZE E.	GEO
10	GIORGADZE V.	GEO
10	KOGHOASHVILI G.	GEO
13	GHARIBADZE Koka TBL	GEO



Feuille de compétition / Competition Sheet

Georgian Championship in GR Style Junior



STYLE : GR 96 kg



12 BARBAQADZE G. (GEO)

Classement

Cl	Pays	Nom
1	GEO	BARBAQADZE Giorgi GRDB
2	GEO	BUKHRIKIDZE Saba TBL
3	GEO	PATARAIA Nikoloz TBL
3	GEO	KALANDADZE Kakha OZRG
5	GEO	KUSHTANASHVILI Beslani AKHM
5	GEO	GIORGEBIANI Gurami TBL ORC
7	GEO	MARSHANIA Giorgi TBL
8	GEO	IREMADZE Mamuka AJR
9	GEO	FUTKARADZE Zviadi AJR
10	GEO	ORBELADZE Giorgi ZSTF
11	GEO	MANCHKHASHVILI Giorgi TBL
12	GEO	ALBORISHVILI Givi TSKLTB

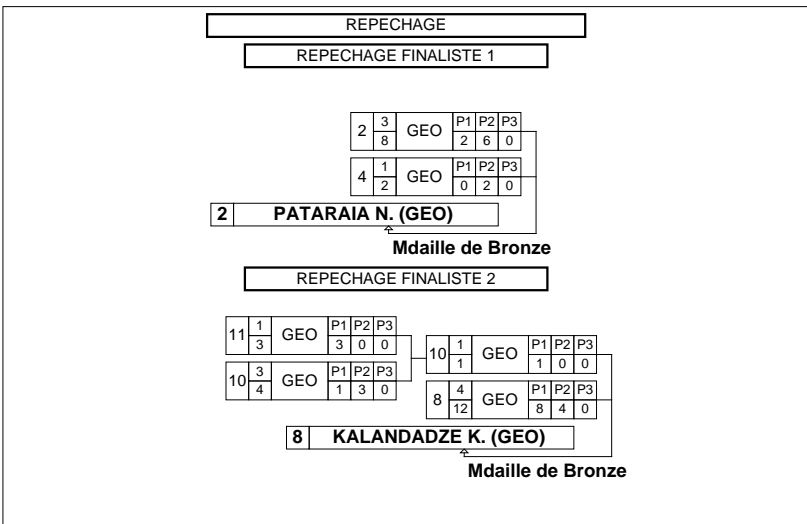

Classement**Georgian Championship in GR Style Junior**

STYLE : GR 96 kg

UNITED WORLD
WRESTLING**1 - Or / Gold**

BARBAQADZE Giorgi GRDB

2 - Argent / Silver

BUKHRIKIDZE Saba TBL

3 - Bronze

PATARAIA Nikoloz TBL KALANDADZE Kakha OZRG

<i>Classement</i>	<i>Nom - Name</i>	<i>Pays - Country</i>
1	BARBAQADZE G.	GEO
2	BUKHRIKIDZE S.	GEO
3	PATARAIA N.	GEO
3	KALANDADZE K.	GEO
5	KUSHTANASHVILI B.	GEO
5	GIORGOBIANI G.	GEO
7	MARSHANIA G.	GEO
8	IREMADZE Mamuka AJR	GEO
9	FUTKARADZE Z.	GEO
10	ORBELADZE G.	GEO
11	MANCHKHASHVILI G.	GEO
12	ALBORISHVILI G.	GEO